



INDICATIVE PHOTO

General features : RCMR3350606

RCMR ø350 range unit coolers have been designed to be installed inside cold rooms suited for fresh and frozen goods storage

This range completes the RC and RCS range applications and though having extremely compact dimensions, reaches bigger capacities suited for medium size cold rooms

RCMR ø350 range is available in different combinations of fin spacing dimensions and tube rows properly sized according to the needed applications

The ED version is supplied with mounted defrosting heaters and is suitable for being used at low temperature applications

The fan motors operate in the suction mode and prevent the condensate forming on the fan

The coil is made of aluminium fins, 12 mm copper tube and a geometry of 37,5 x 32,5

RCMR ø350 unit coolers can be classified in three groups according to the needed cold room temperature (Tc): 4mm fin spacing for a Tc from -5°C to +15°C; 6mm fin spacing for a Tc from -20°C to +15°C; 8mm fin spacing for a Tc from -40°C to +4°C.

The coils are tested with nitrogen at a pressure of 25 bar.

The fan motor models in use have the following features:

Manufactured following EN 60335-1 laws, with internal thermal protection

Fan diameter 350 mm, external rotor

Power supply 230-240V/1/50-60Hz

IP44 protection rate

F insulation class

operating temperature -40°C a +65°C

Electrics made in conformity with 2006/95/CE Low Tension directive

The housing is made of aluminium

The manufacturing solutions used give the housing strength and guarantee the absence of vibrations during the functioning.

Screws, washers and nuts are made of stainless steel



INDICATIVE PHOTO

Product file : Unit coolers

Code	RCMR3350606
Model	Ceiling cubic unit cooler
Range	RCMR
Application	MBP
Net weight	56,8 kg
Inlet connection	22 mm
Outlet connection	35 mm
Drain connection	1" Gas (33mm)
Ped	0
Rows	6
Fin spacing	6
Circuit volume	11,1 dm ³
Total surface	35,9 m ²

Fan motor

Type	AC
Fans no.	3
Diameter	350 mm
Power supply	230/1/50-60
Speed	1400 rpm
Power consumption	390 W
Current consumption	1,74 A
Air flow	5990.5 m ³ /h
Air throw	16 m

Technical drawing - RCMR3350606

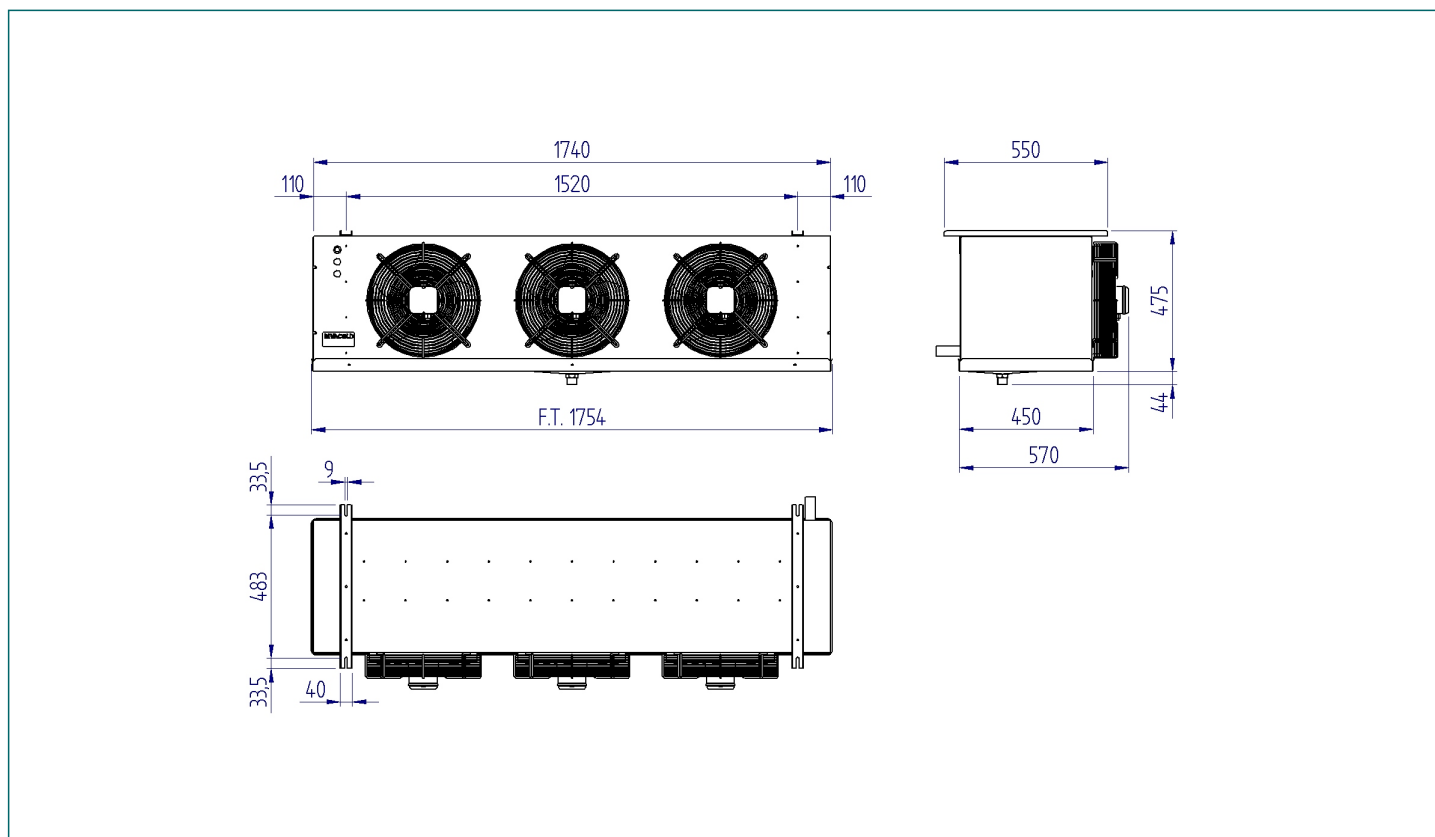

Refrigerating capacity table (watt) - Gas : R404A

dT \ Tc	-20°C	-15°C	-10°C	-5°C	0°C	2°C	4°C	6°C	8°C	10°C	12°C	15°C
10	11800 ⁽¹⁾	12400	13100	13900	14700	15000	15200	15300	15600	15800	16200	16800
9	10700 ⁽¹⁾	11400	12000	12700	13500	13700	13800	14000	14200	14600	14900	15350
8	9740 ⁽¹⁾	10300	10800	11400	12200	12300	12500	12700	12800	13200	13500	13950
7	8680 ⁽¹⁾	9120	9590	10100	10800	11000	11100	11200	11500	11800	12100	12550
6	7570 ⁽¹⁾	7950	8370	8880	9540	9640	9750	9920	10200	10500	10800	11250
5	6420 ⁽¹⁾	6730	7110	7580	8210	8280	8400	8640	8920	9220	9530	9995

(1) Applicazione fuori dal campo consigliato